



54



XM
542-1/20

5

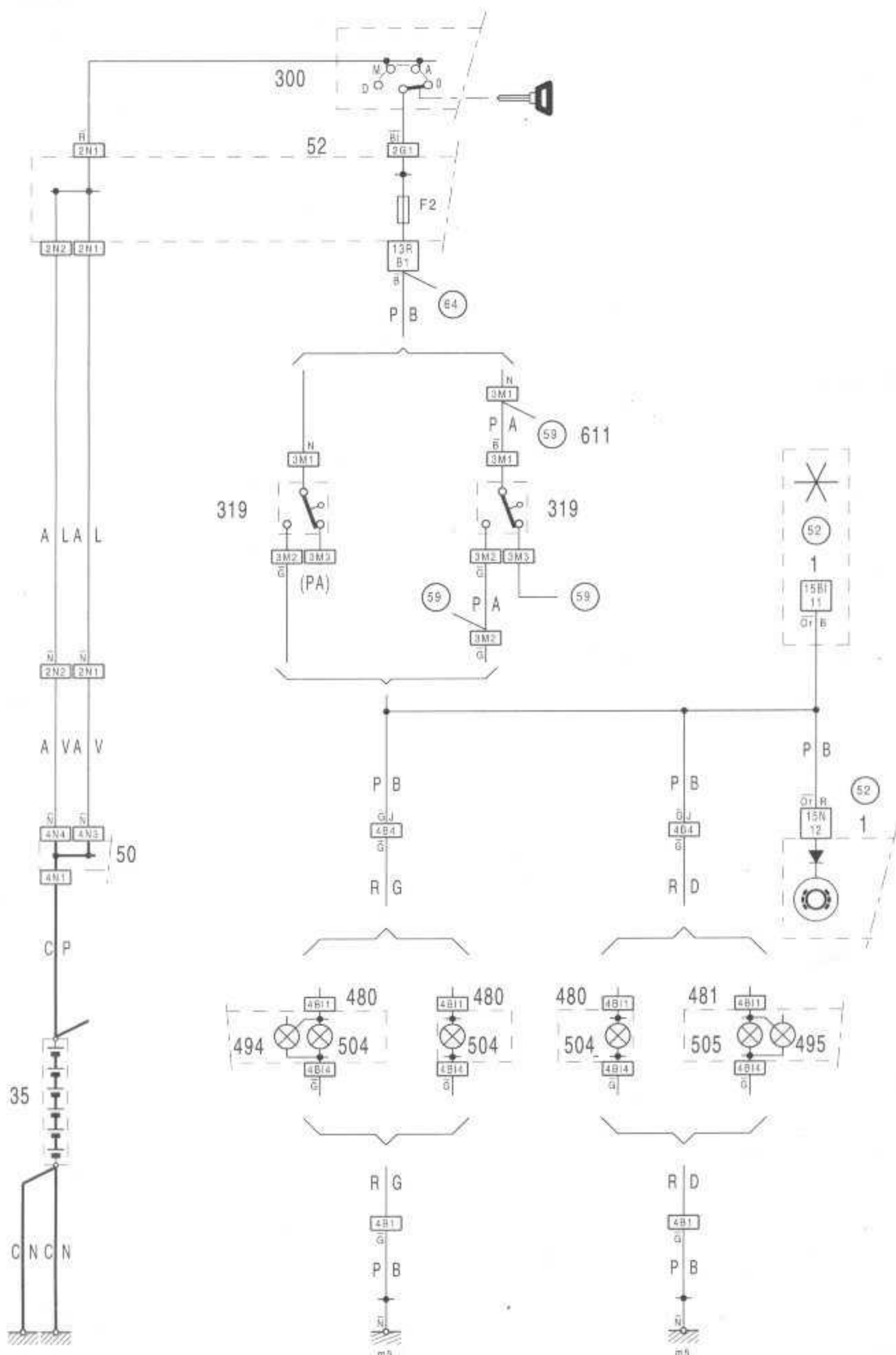

542-1/20

542-1/20

1 2 3 4 5 6 7 8 9 10 11 12 13 14 15 16 17 18 19 20 21 22 23 24 25 26 27 28 29



54

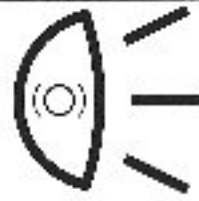

XM
542-1/20a

5

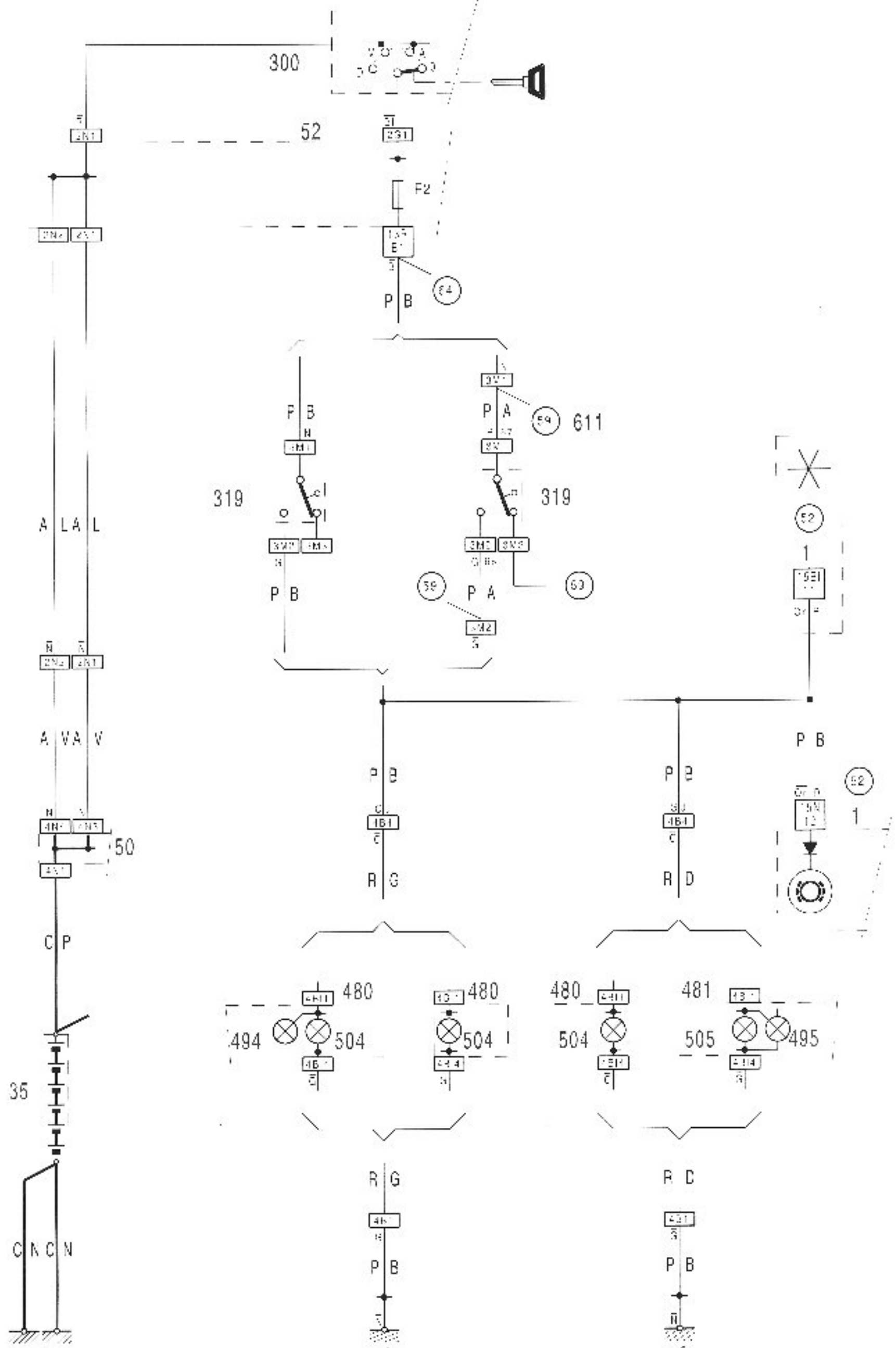



54

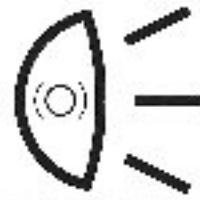

XM
542-1/20b

5

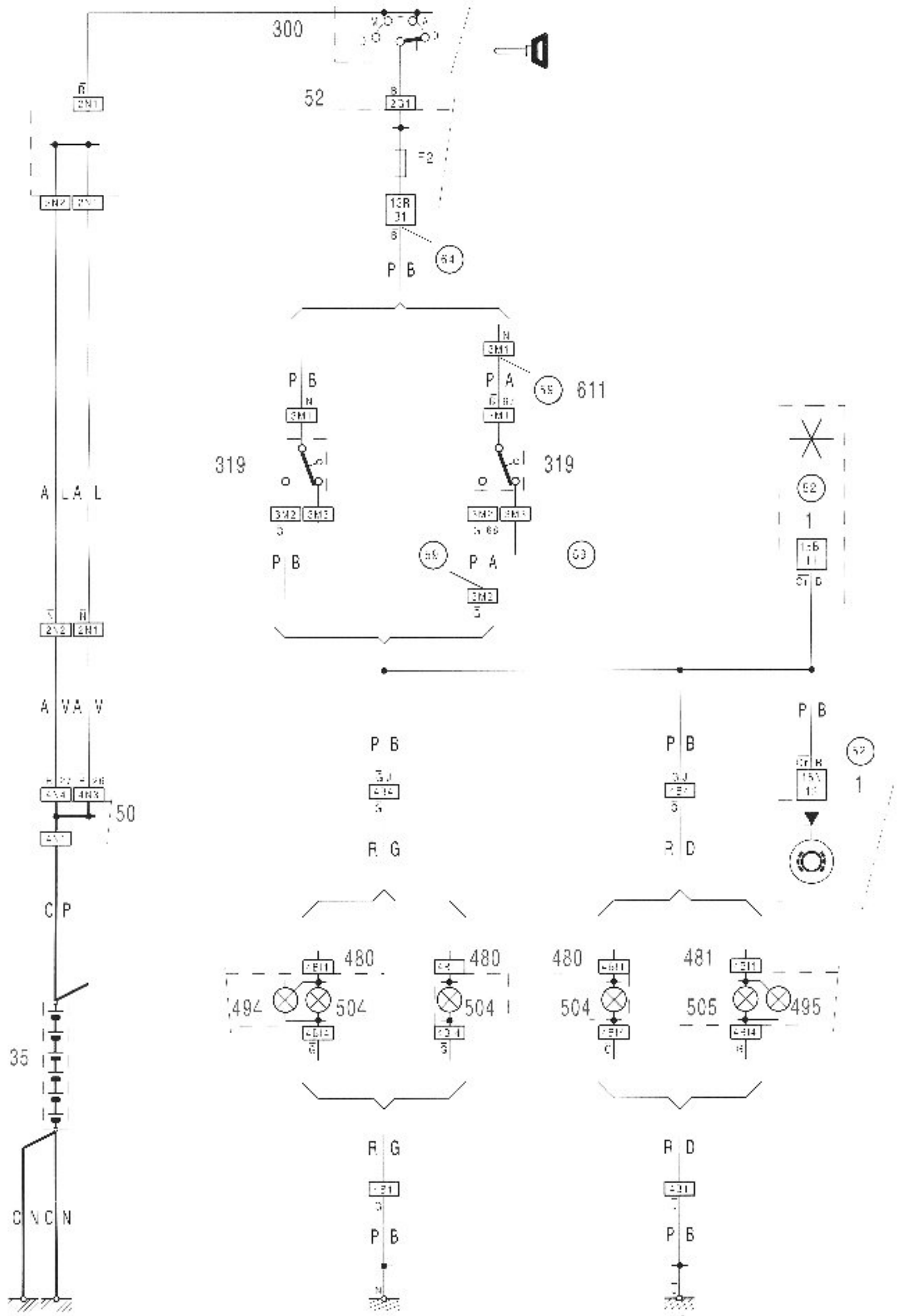

1 2 3 4 5 6 7 8 9 10 11 12 13 14 15 16 17 18 19 20 21 22 23 24 25 26 27 28 29



54

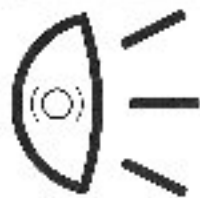

XM
542-1/20c

5

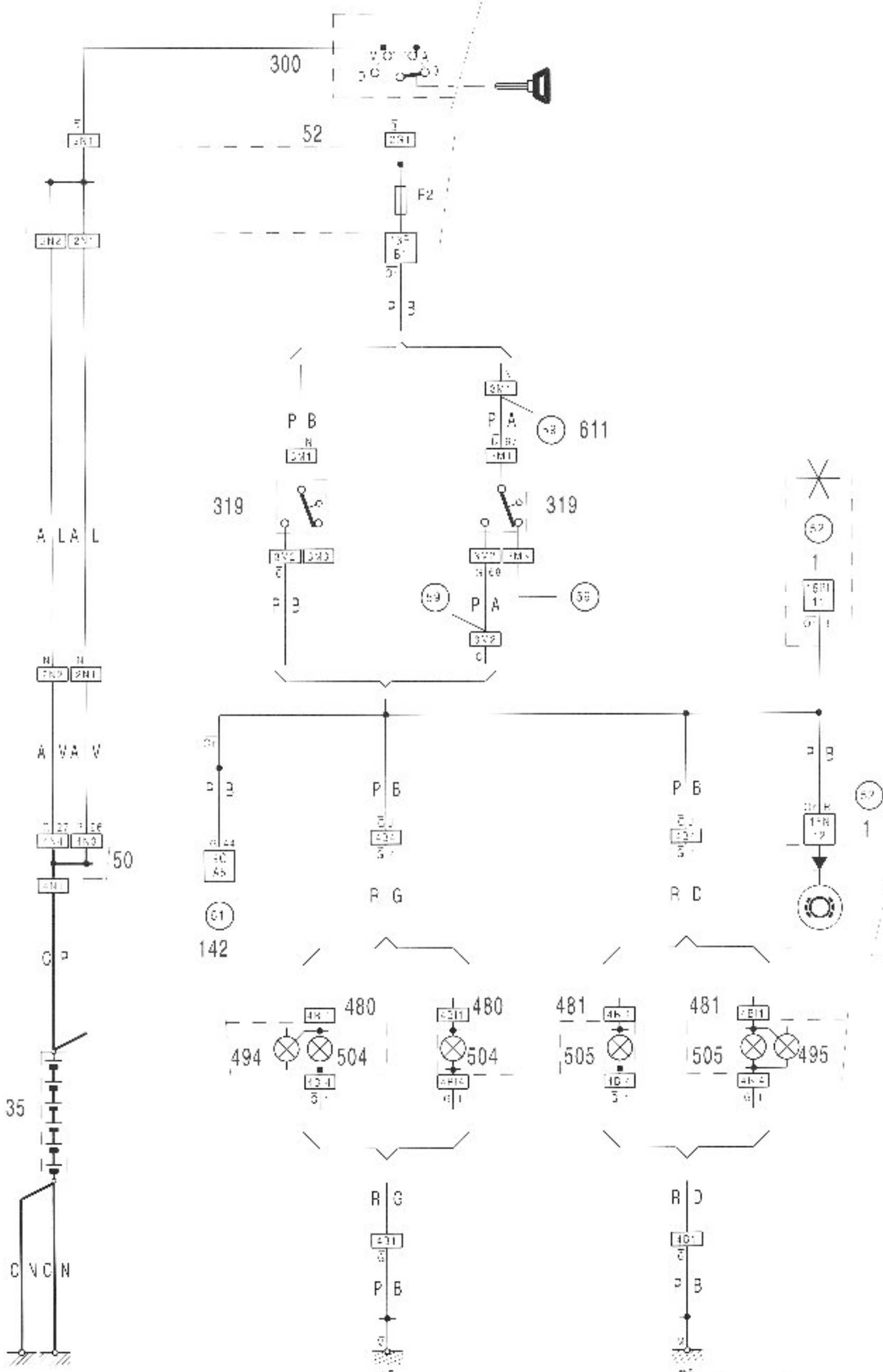

542-1/20c

542-1/20c

1 2 3 4 5 6 7 8 9 10 11 12 13 14 15 16 17 18 19 20 21 22 23 24 25 26 27 28 29



54



XM
542-1/20d

3

4

XM
542-1/20d

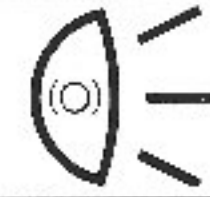

54

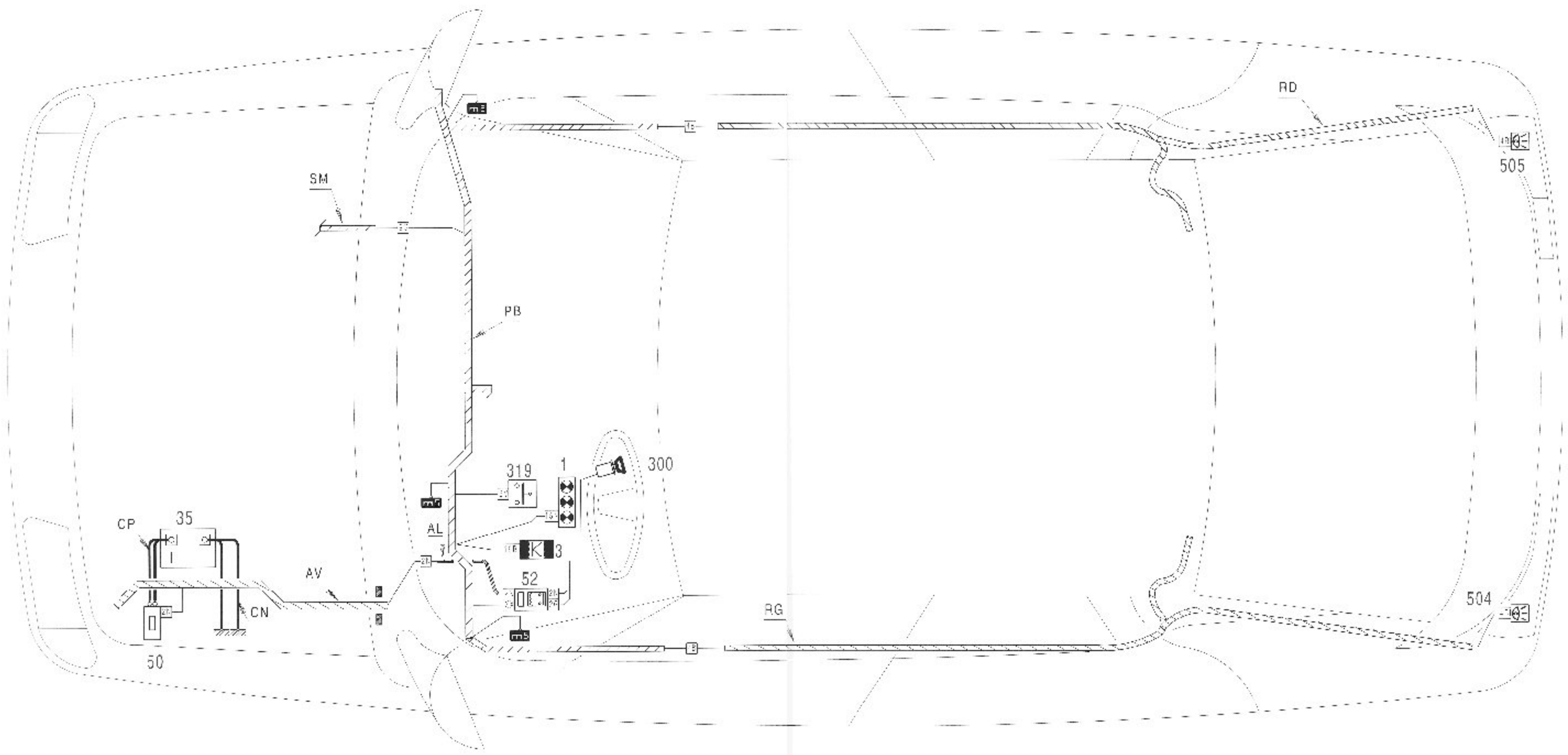

144-1024

2 3 4 5 6 7 8 9 10 11 12 13 14 15 16 17 18 19 20 21 22 23 24 25 26 27 28 29 30 31 32 33 34 35 36 37 38 39 40 41 42 43 44 45 46 47 48 49 50 51 52 53 54 55 56 57 58 59 60 61 62

144-1025



54

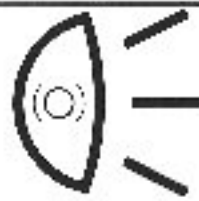

XM
542-1/20d

5

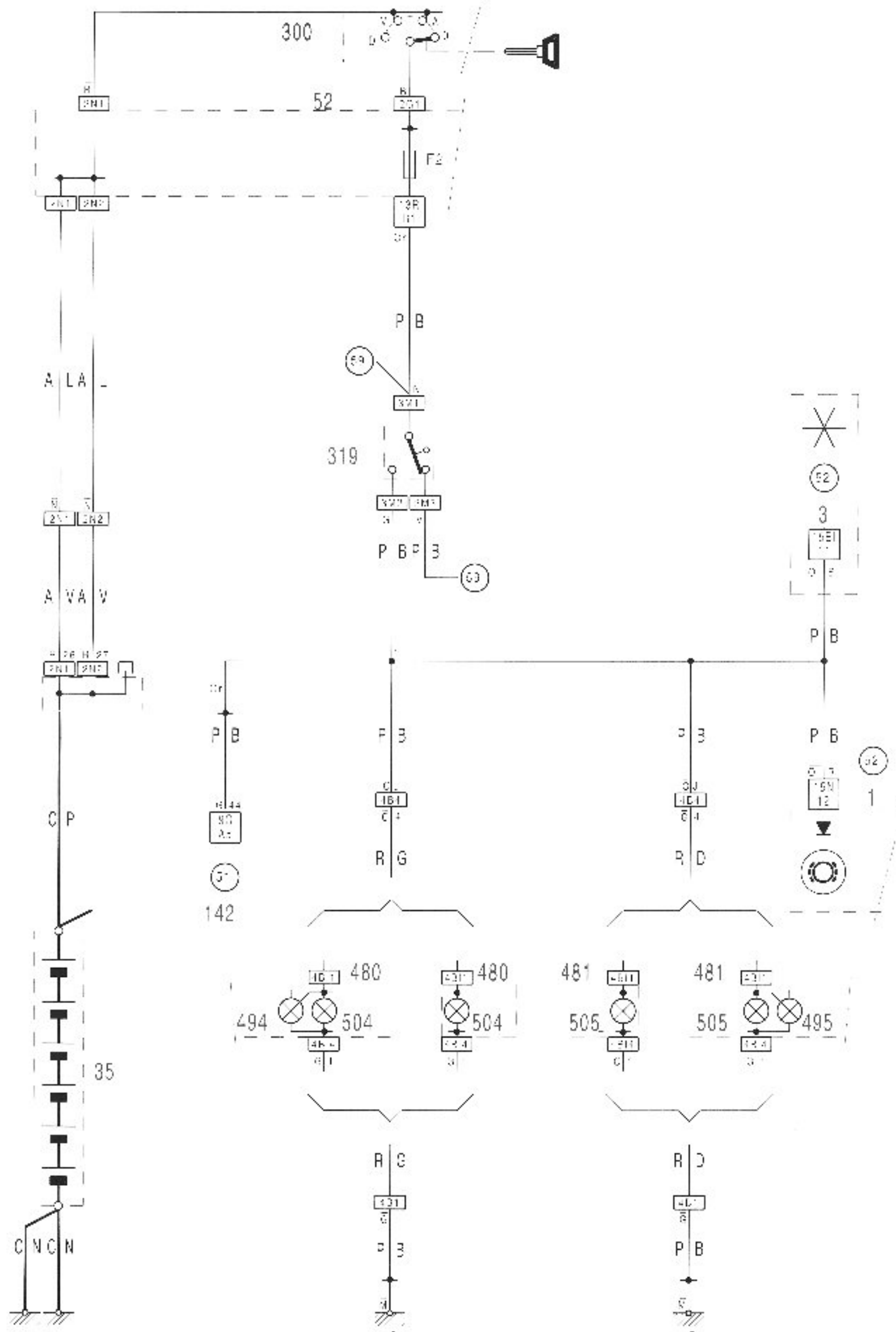

1 2 3 4 5 7 8 10 11 12 13 14 15 16 17 18 19 20 21 22 23 24 25 26 27 28 29



54



XM
541-1/21

5

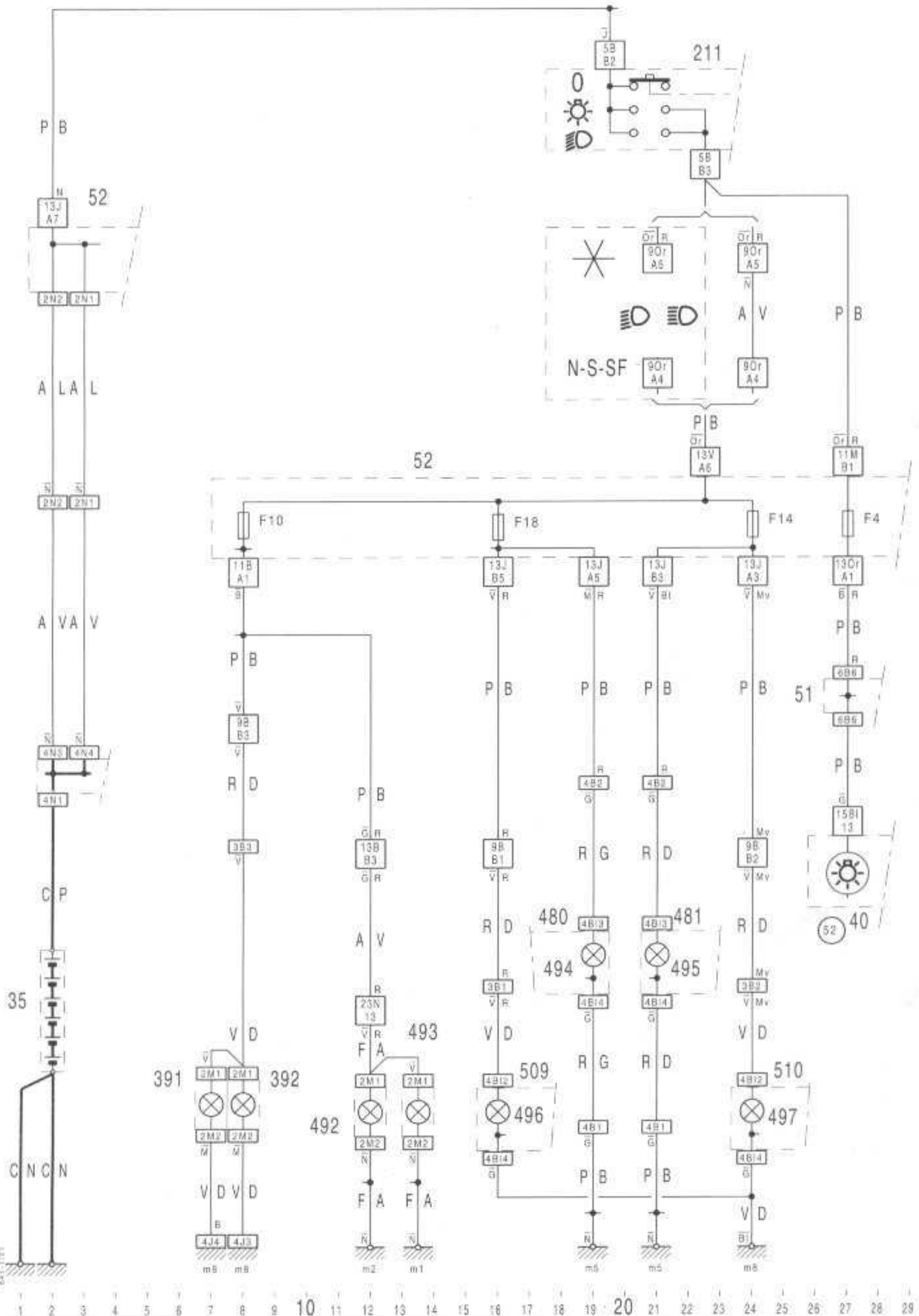



54



XM
541-1/21a

5

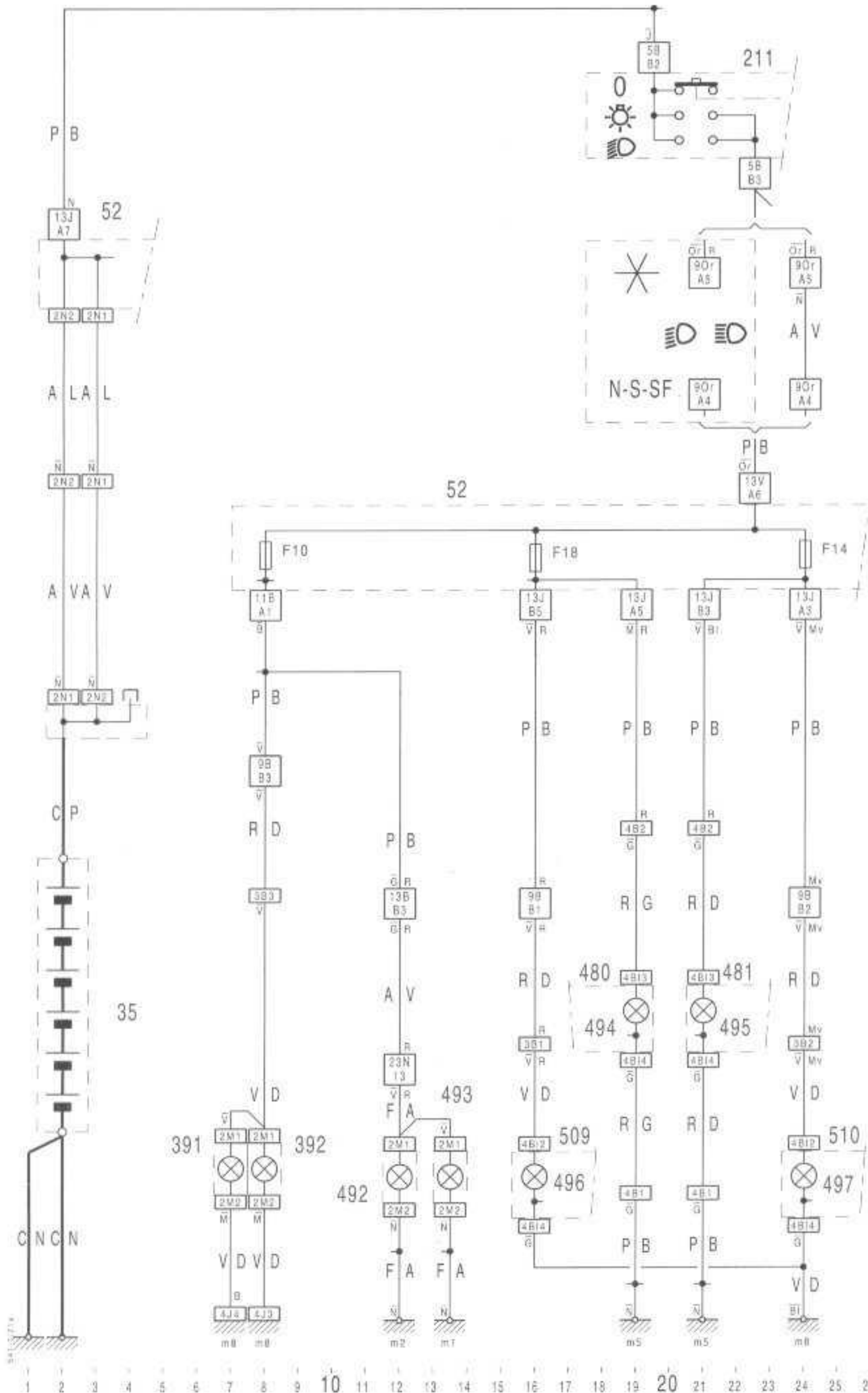



54



XM
542-1/21b

5

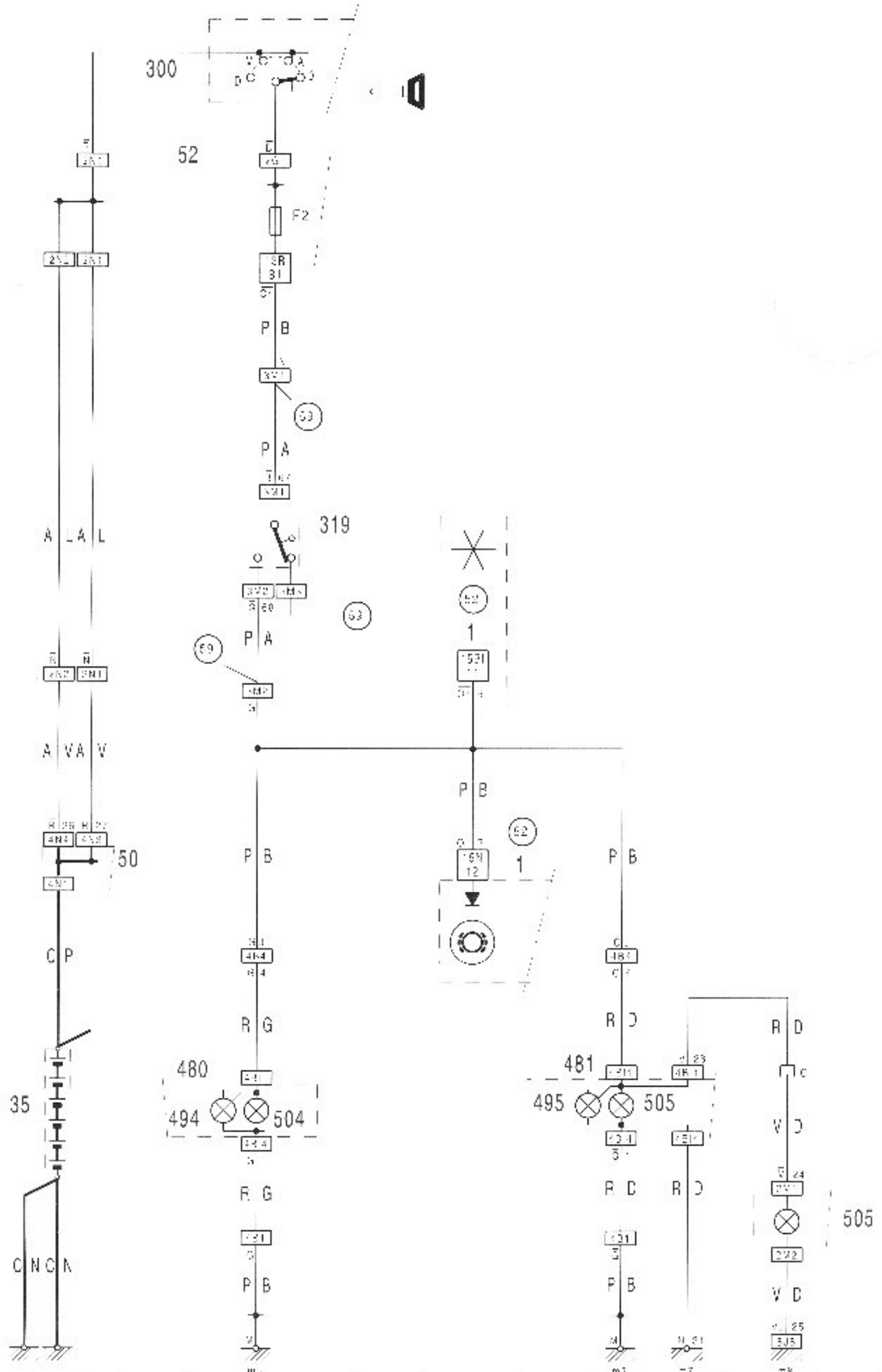



54

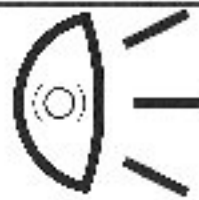

XM
542-1/21c

5

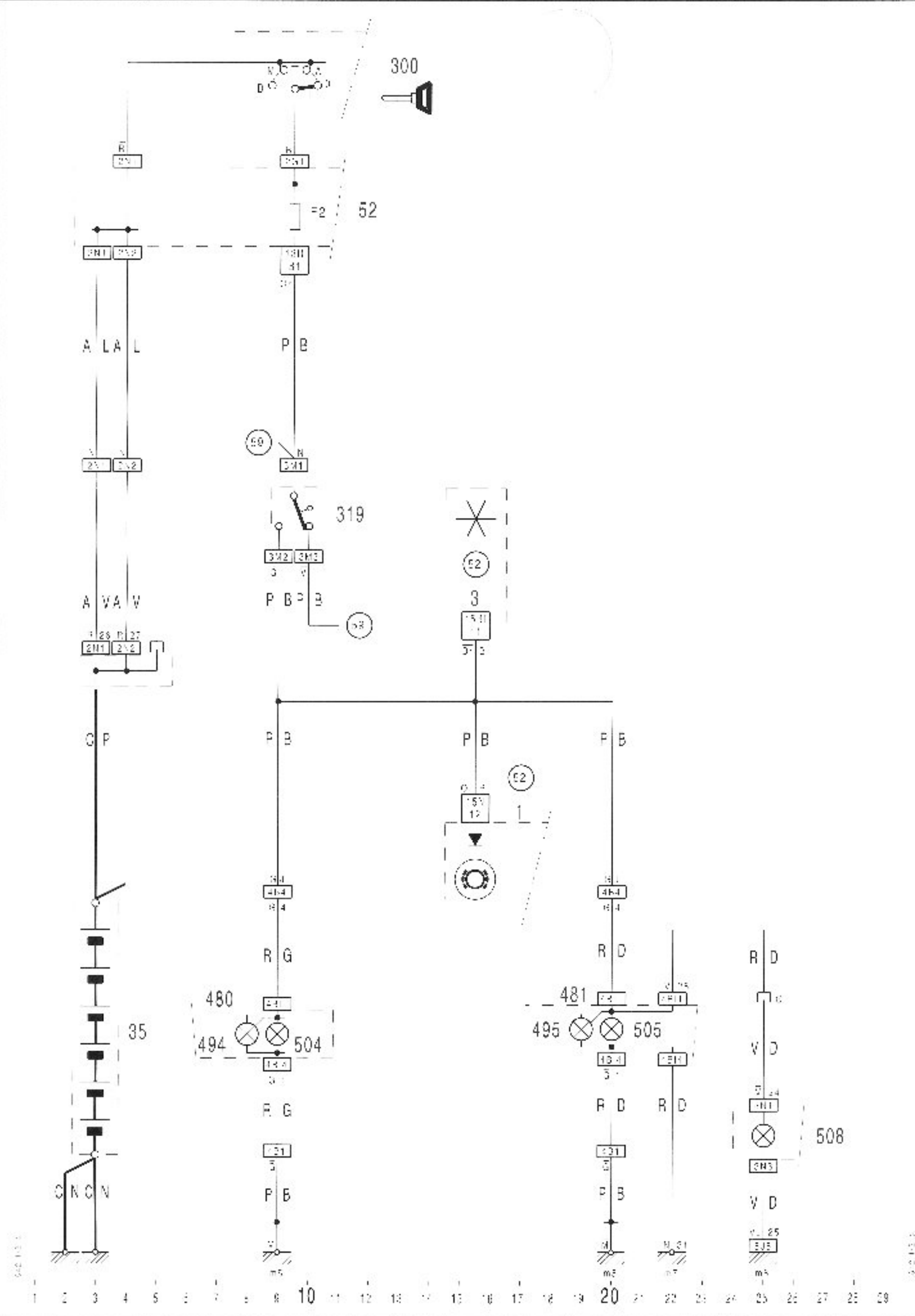



54



XM
542-1/22

3

4

XM
542-1/22

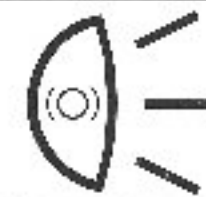

54

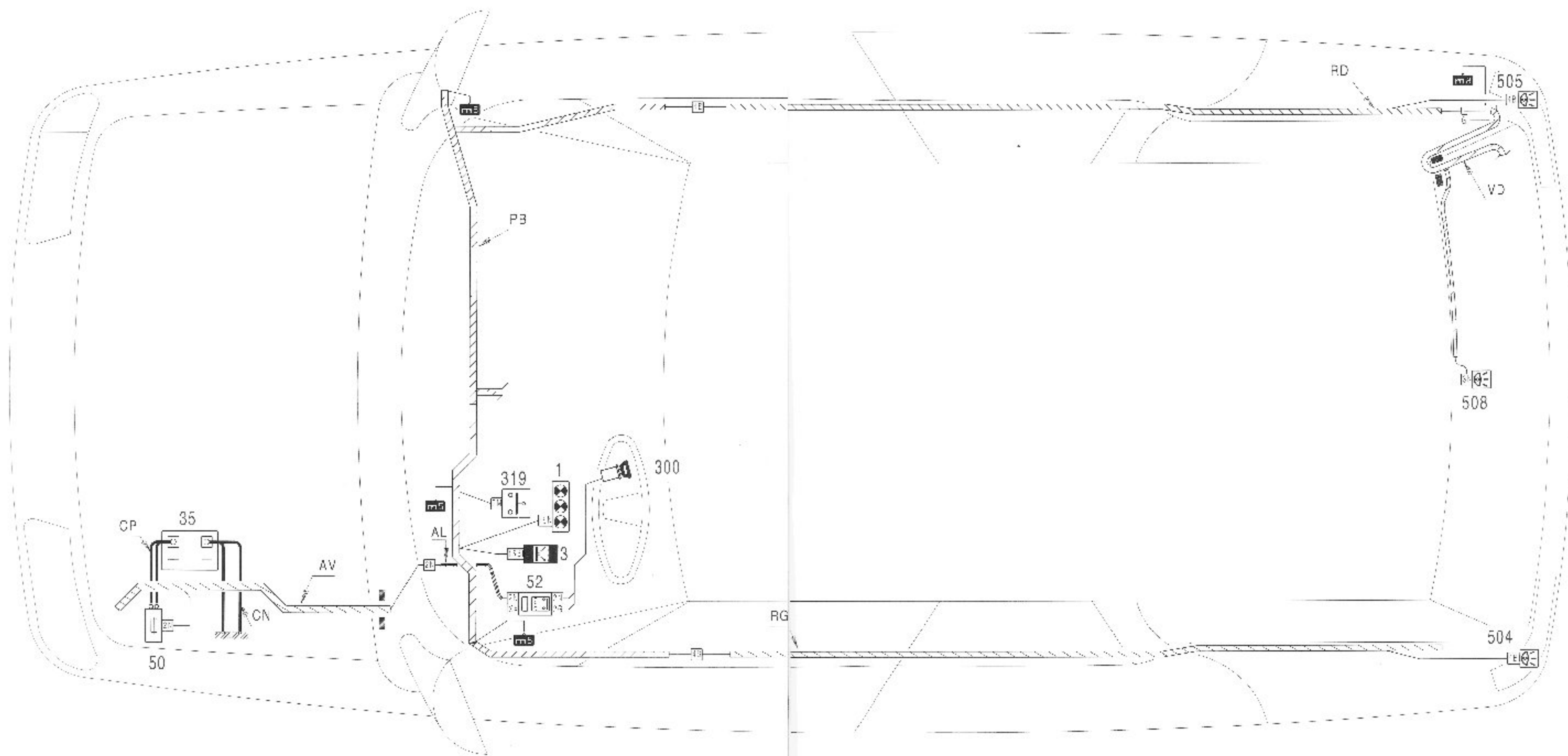

542-1/22

1 2 3 4 5 6 7 8 9 10 11 12 13 14 15 16 17 18 19 20 21 22 23 24 25 26 27 28 29 30 31 32 33 34 35 36 37 38 39 40 41 42 43 44 45 46 47 48 49 50 51 52 53 54 55 56 57 58 59 60 61 62

542-1/22



54



XM
542-1/22

5

