



54



XM
541-1/20

5

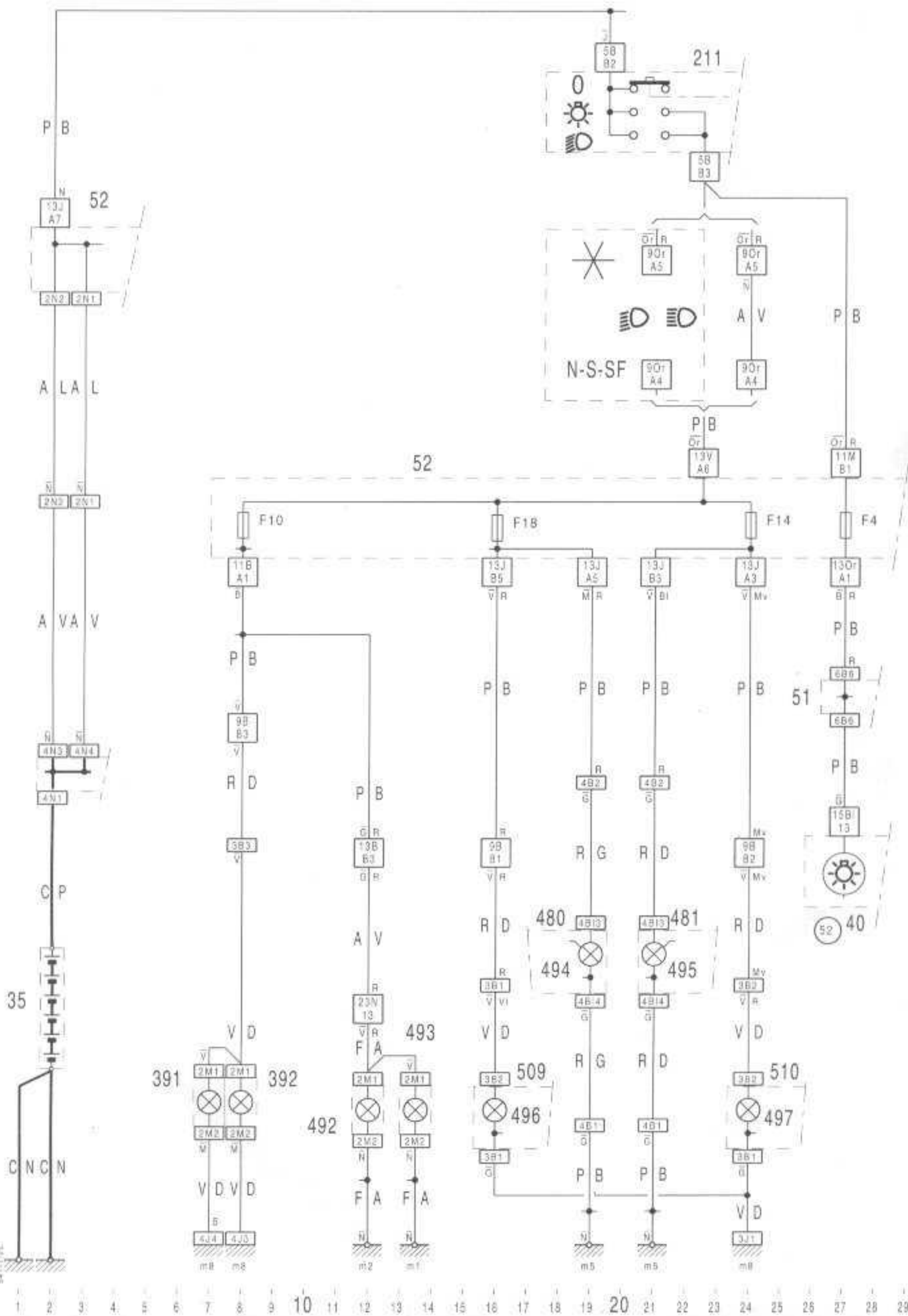



54



XM
541-1/20a

5

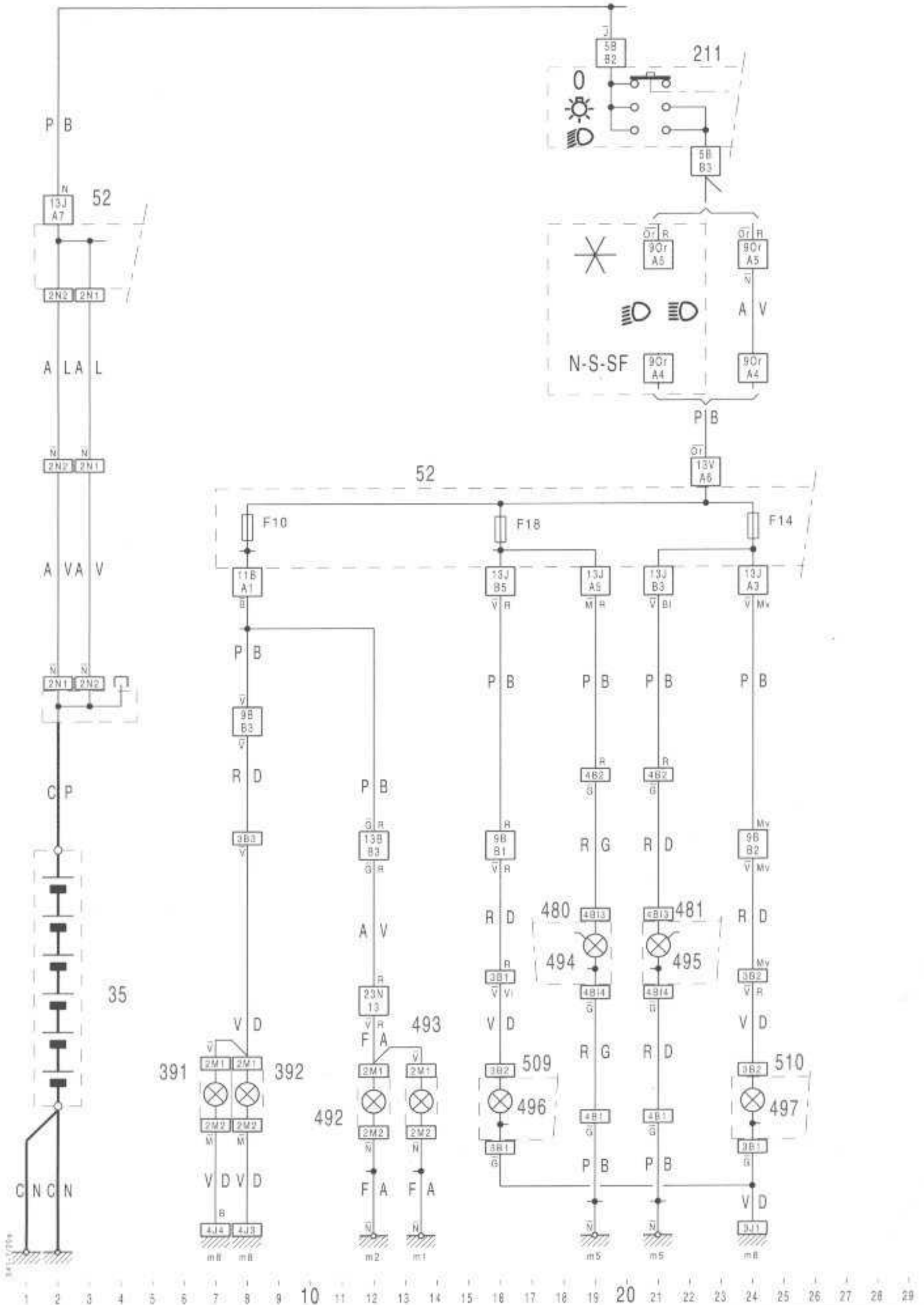



54

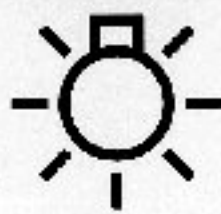

XM
541-1/20b

5

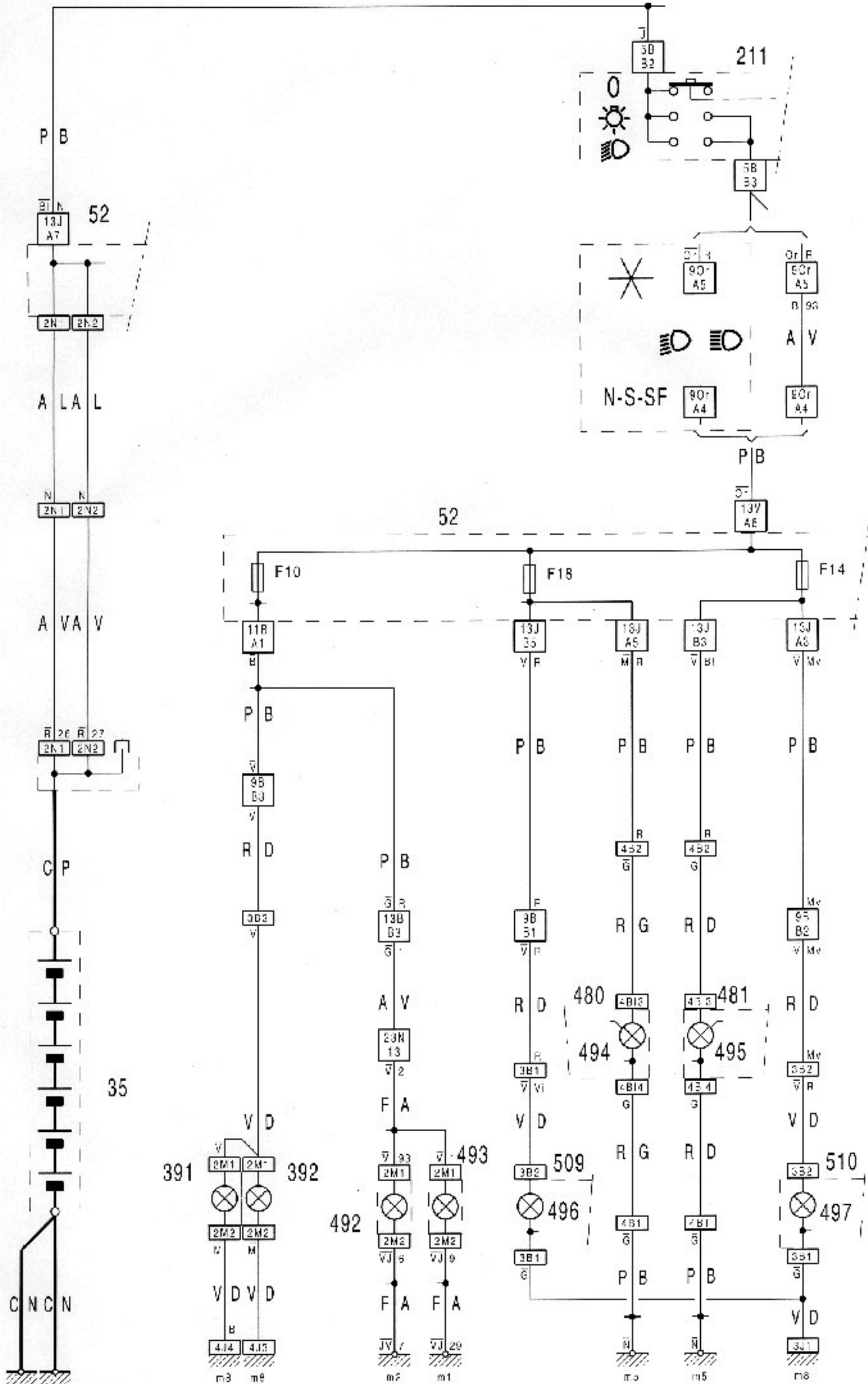



54

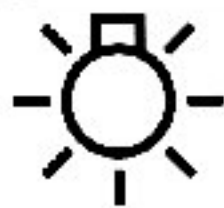

XM
541-1/20c

5

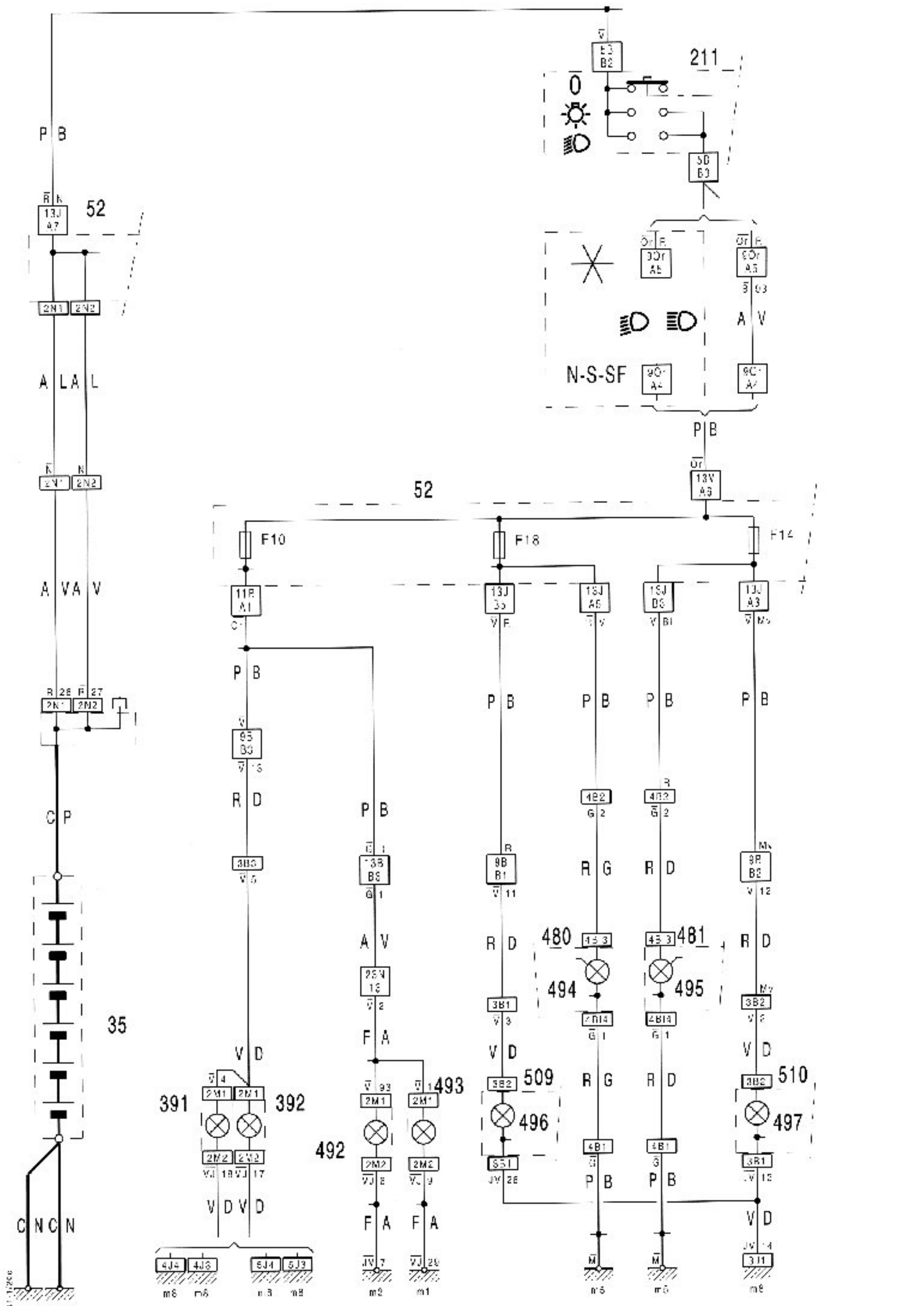



54



XM
541-1/20d

3

XM
541-1/20d

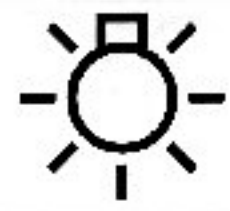

54

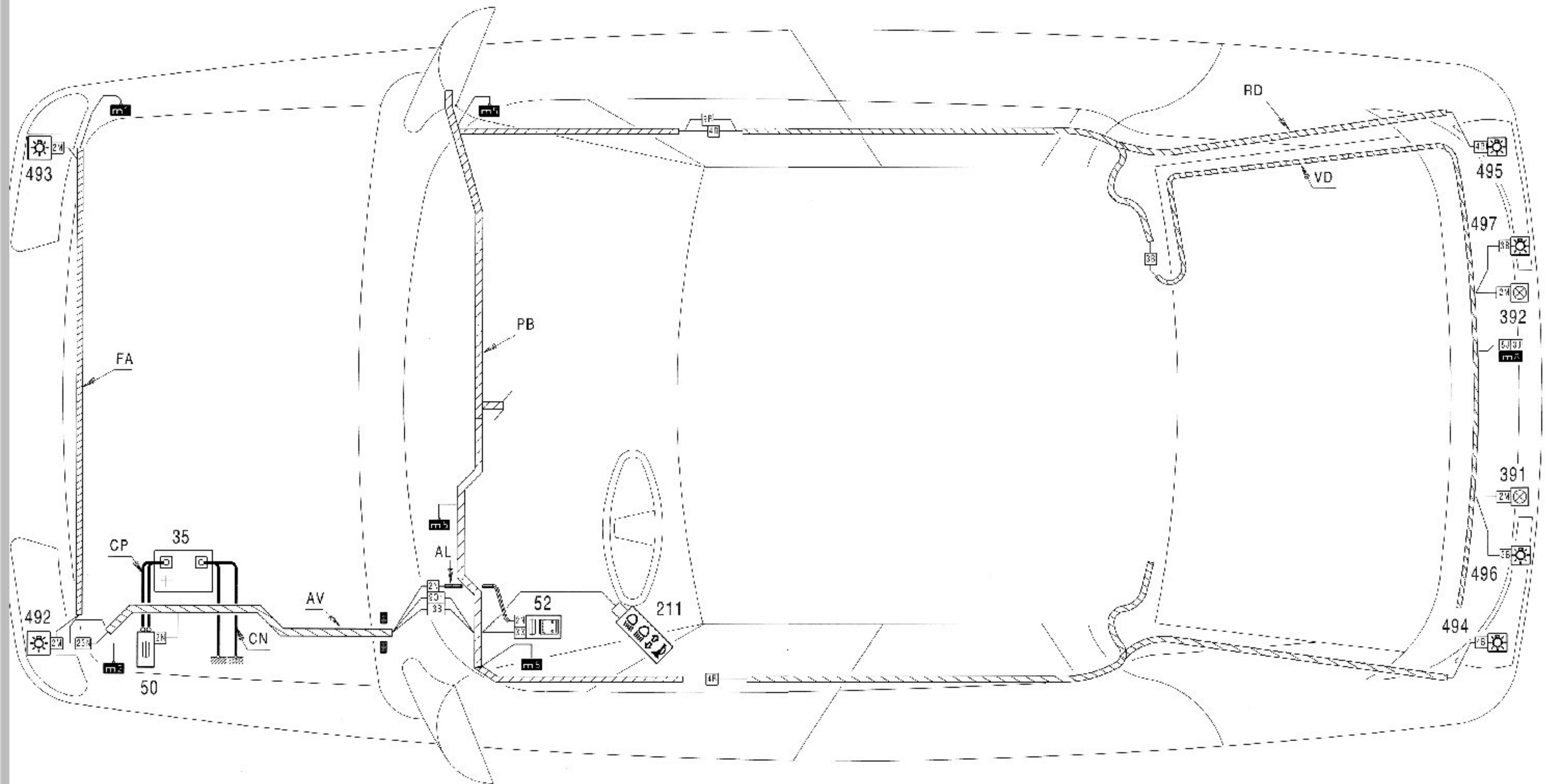



54

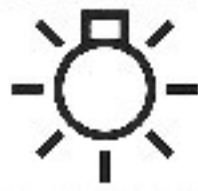

XM
541-1/20d

5

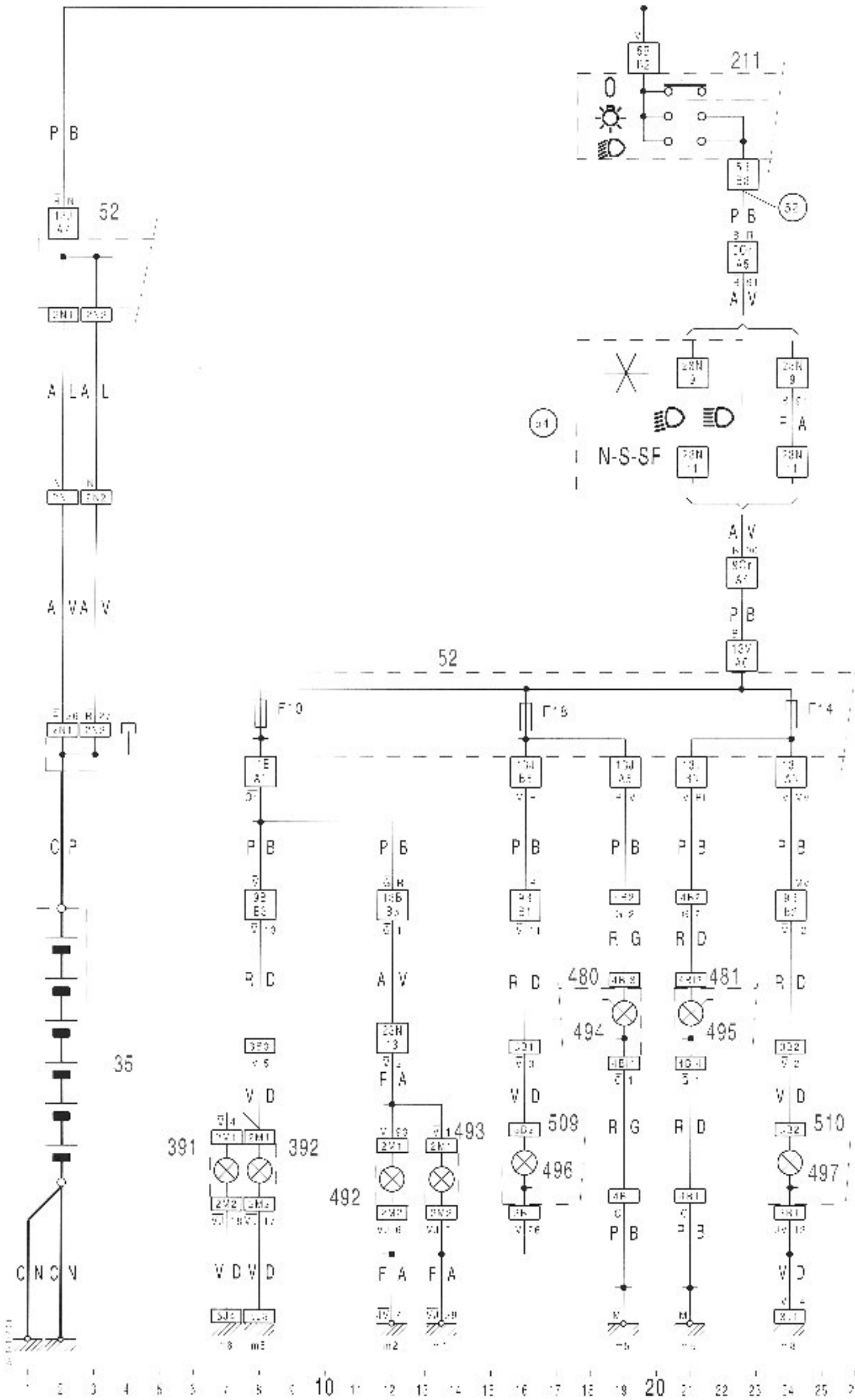



54



XM
541-1/21

5

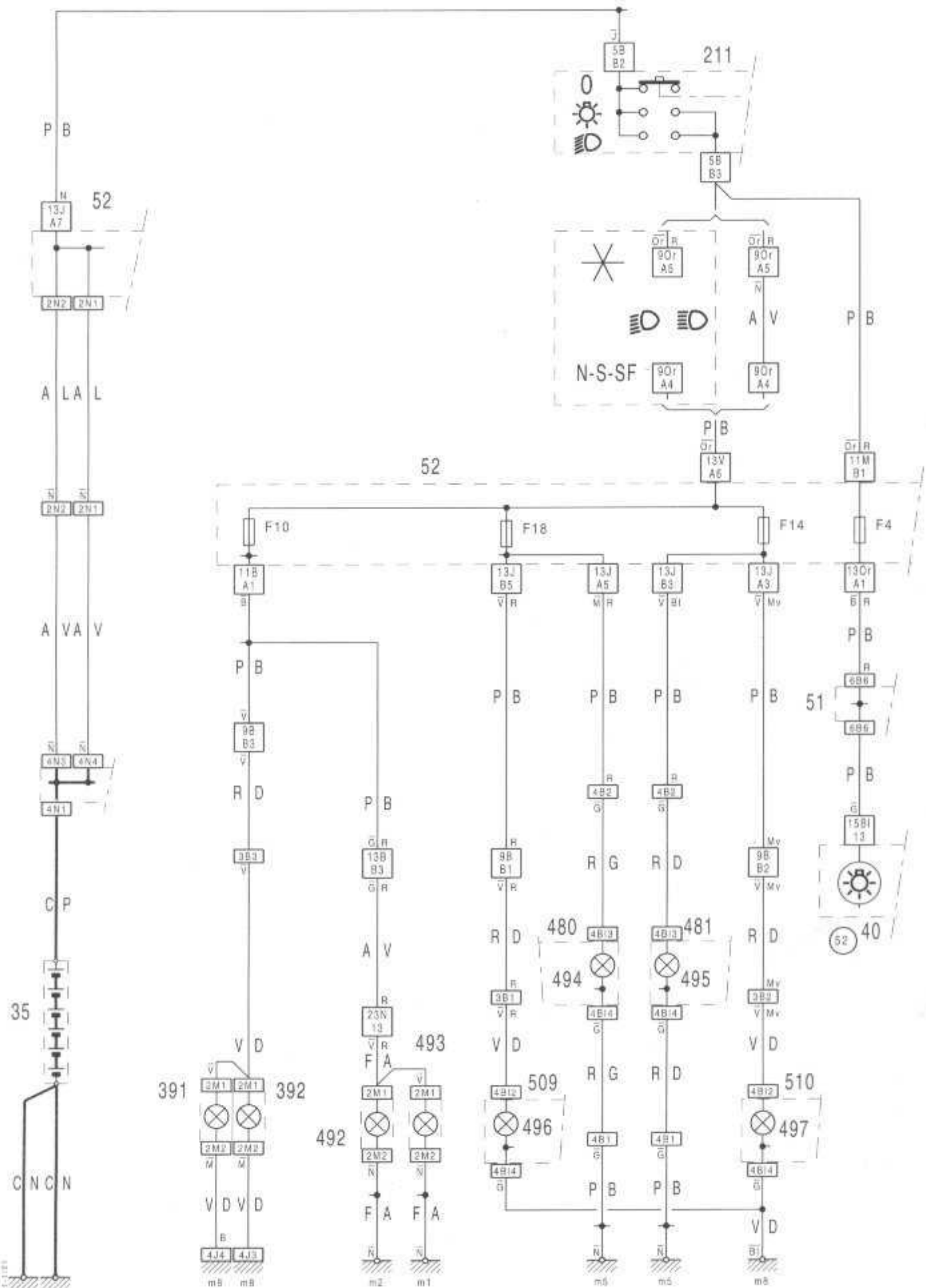

1 2 3 4 5 6 7 8 9 10 11 12 13 14 15 16 17 18 19 20 21 22 23 24 25 26 27 28 29



54



XM
541-1/21a

5

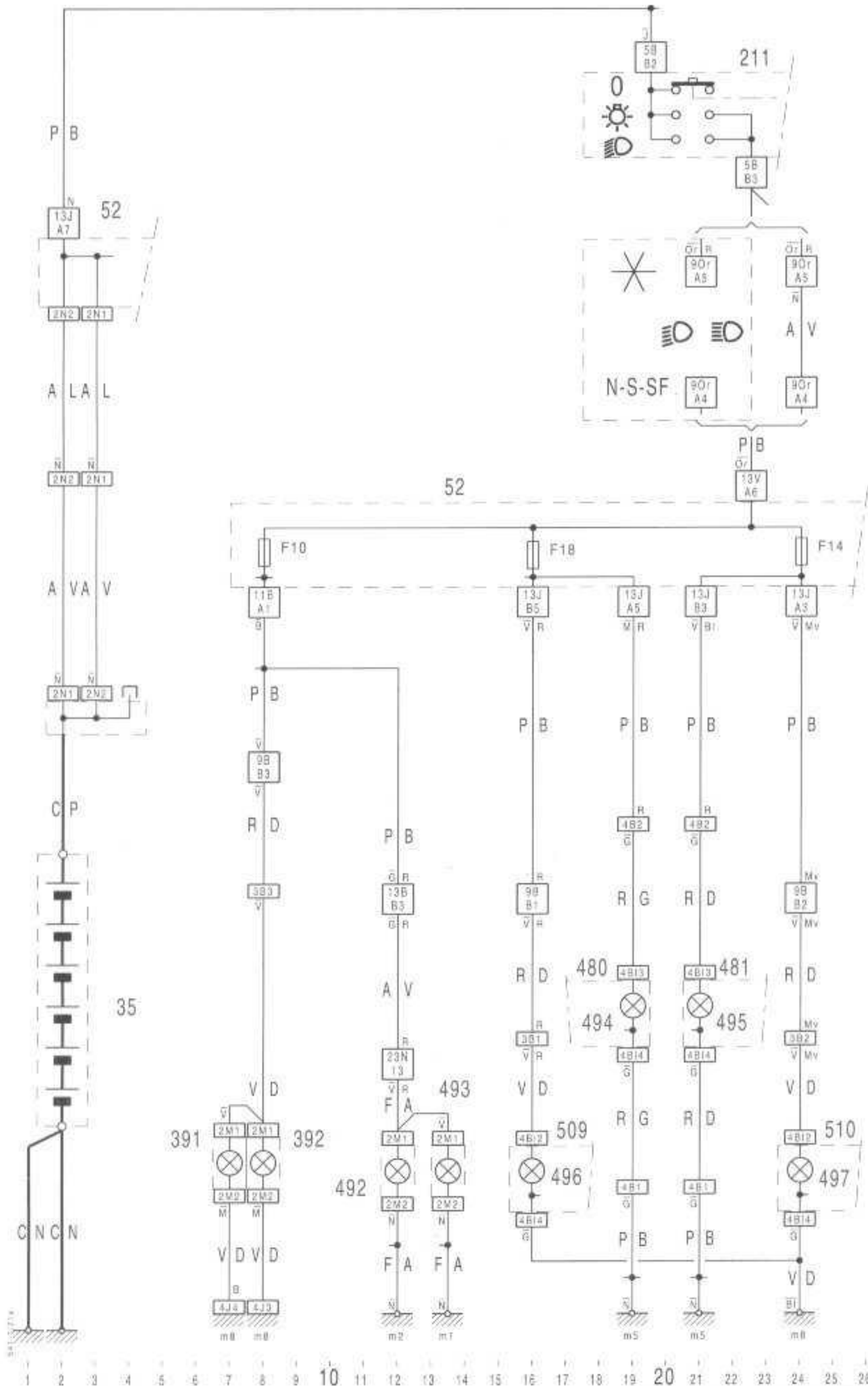



54

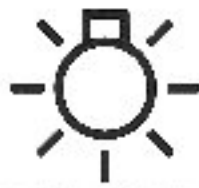

XM
541-1/21b

5

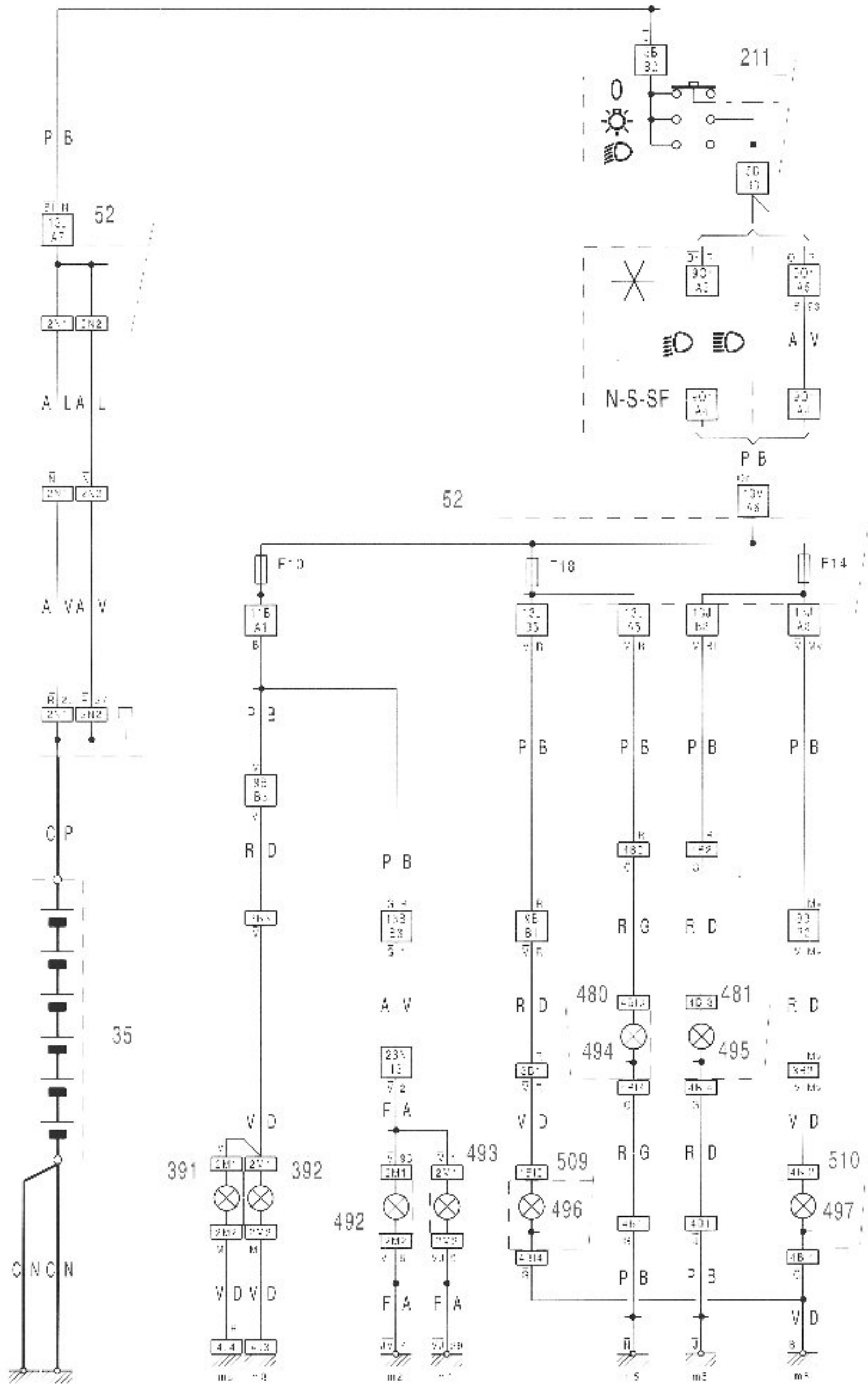

1 2 3 4 5 6 7 8 9 10 11 12 13 14 15 16 17 18 19 20 21 22 23 24 25 26 27 28 29



54



XM
541-1/21c

5

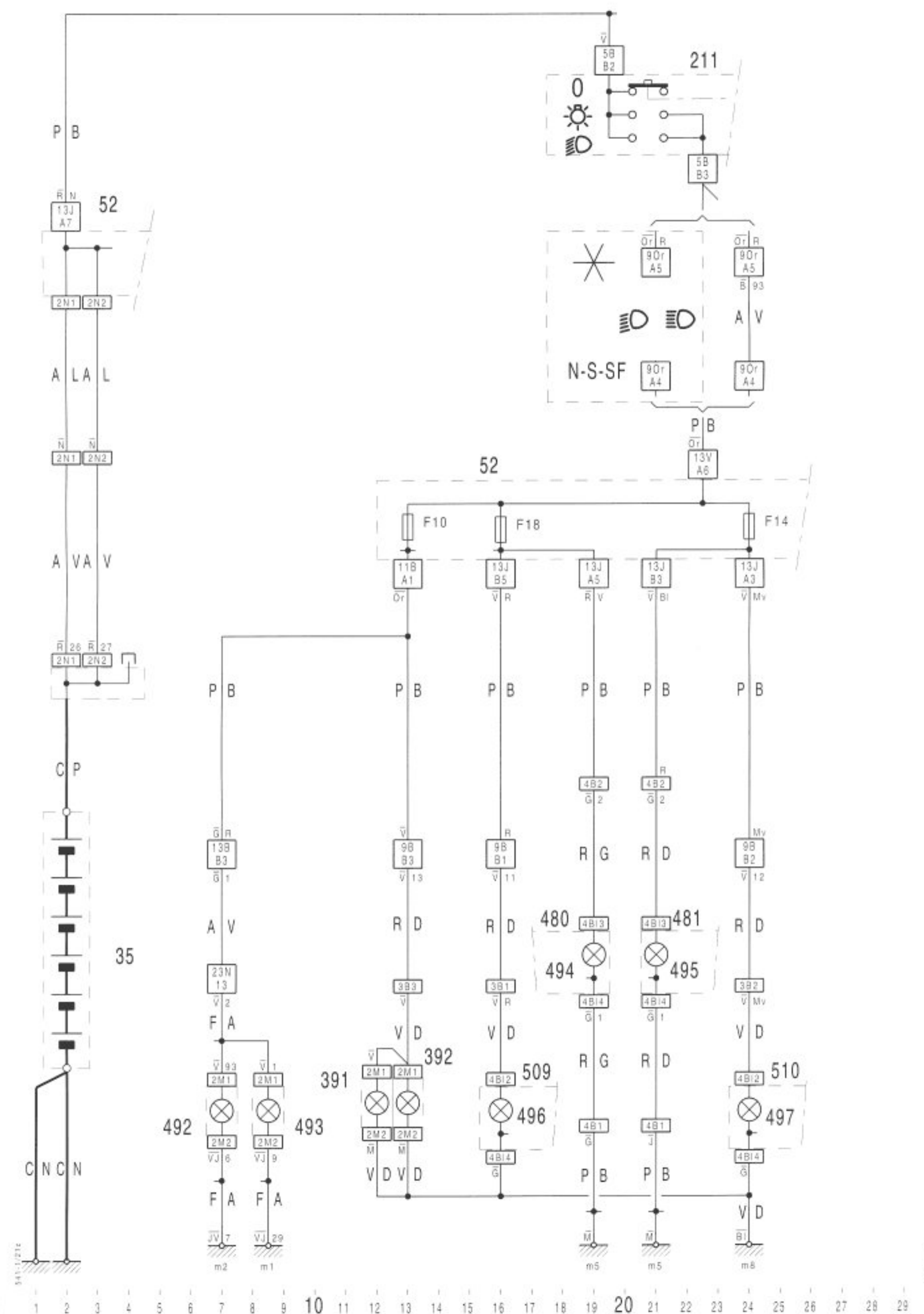



54



XM
541-1/21d

3

4

XM
541-1/21d

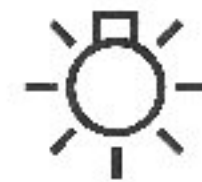

54

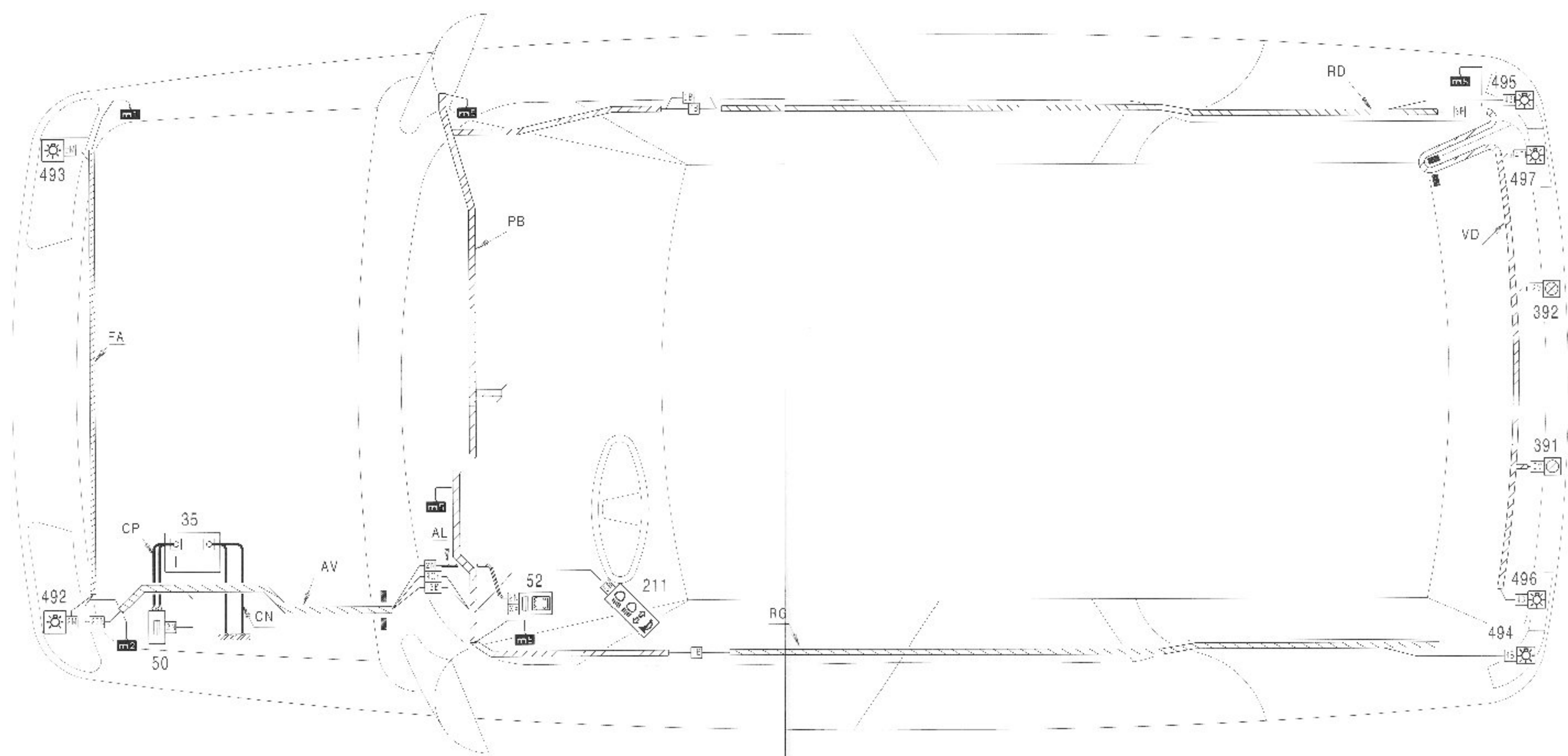



54



XM
541-1/21d

5

