

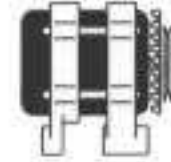

53

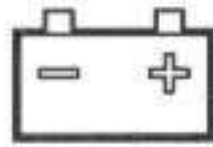

XM
530-0/10

3

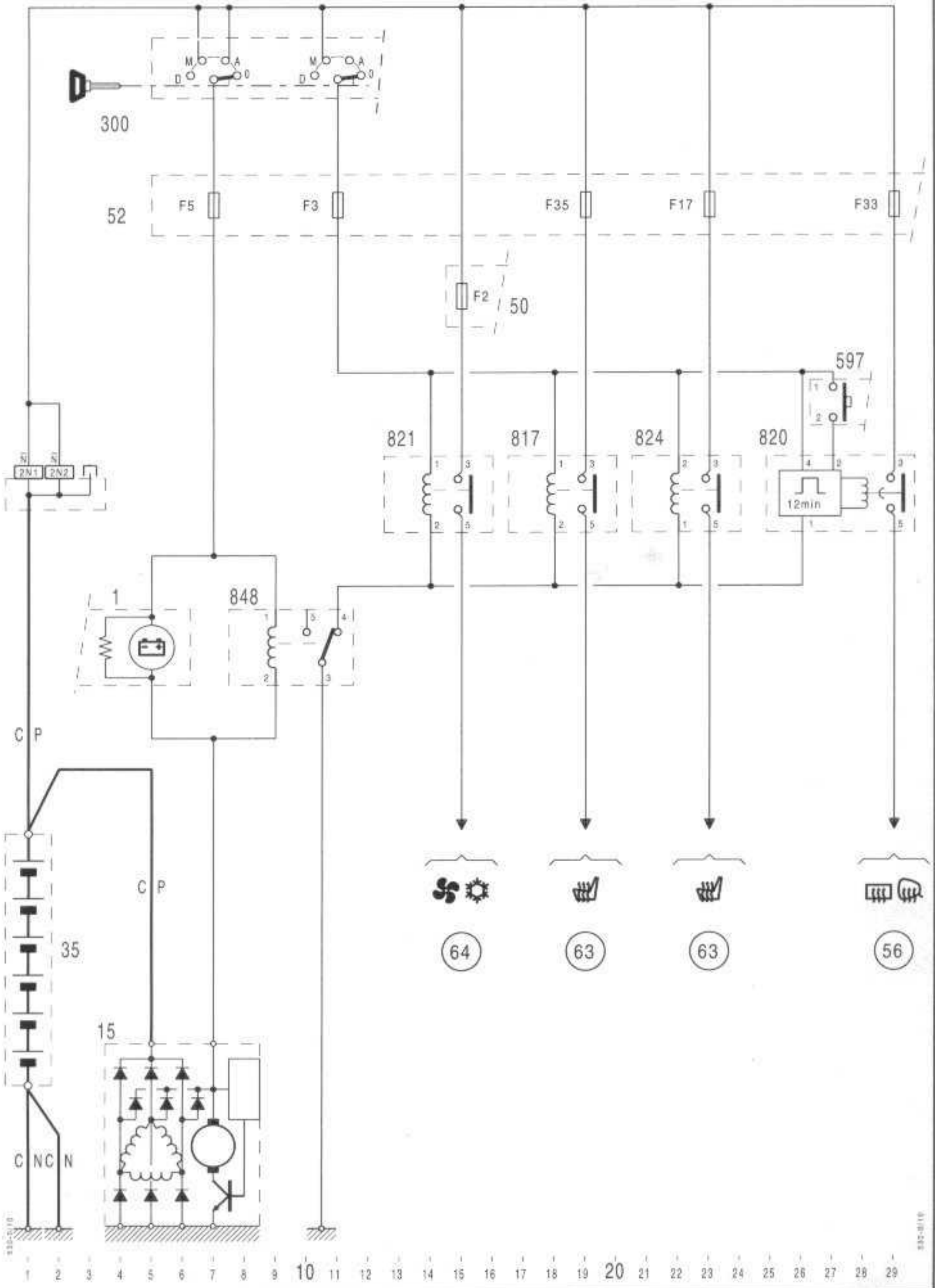



53

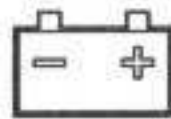

XM
530-0/10a

3

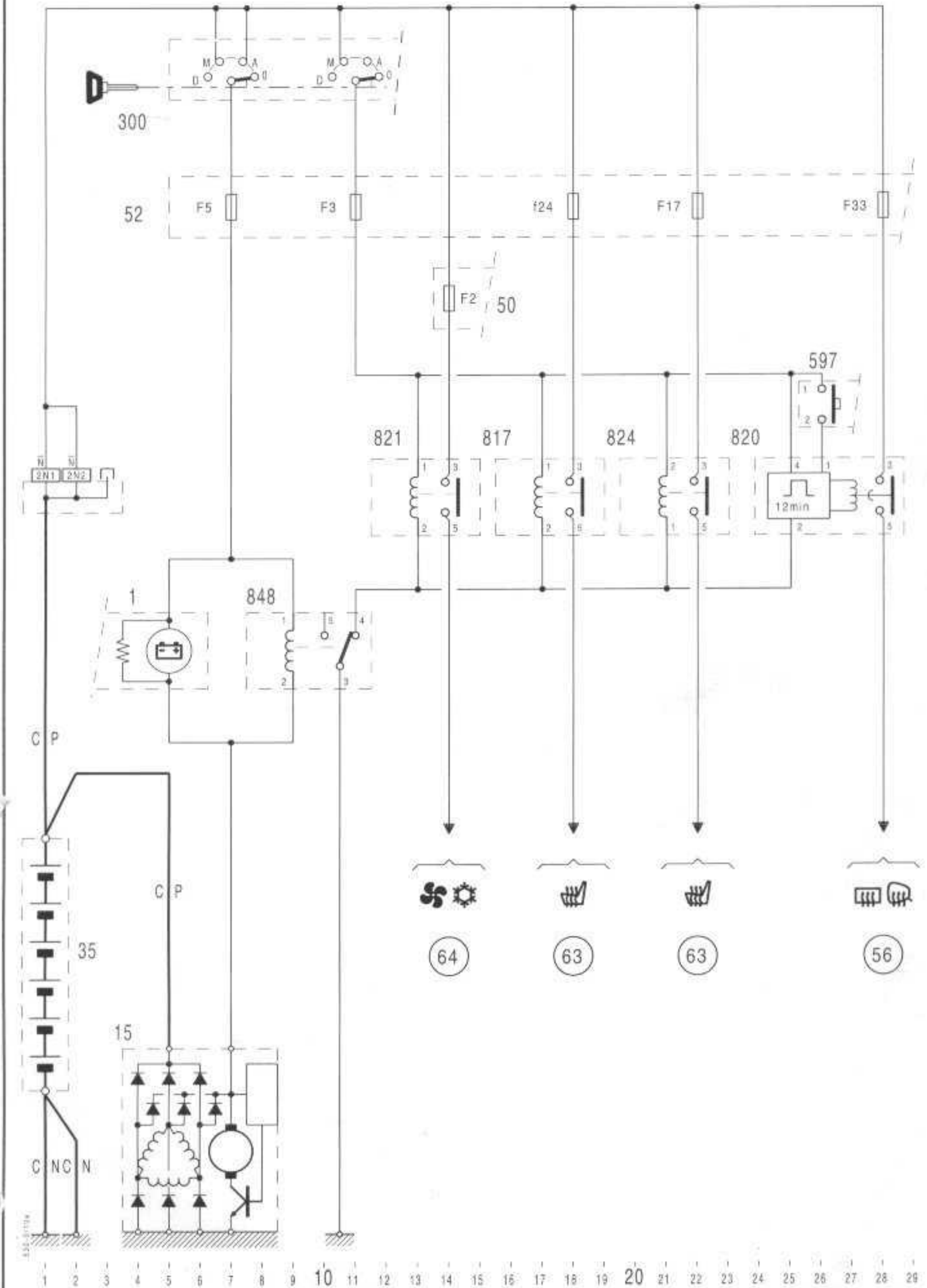



53

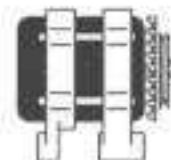
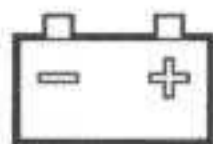

XM
530-0/20

3

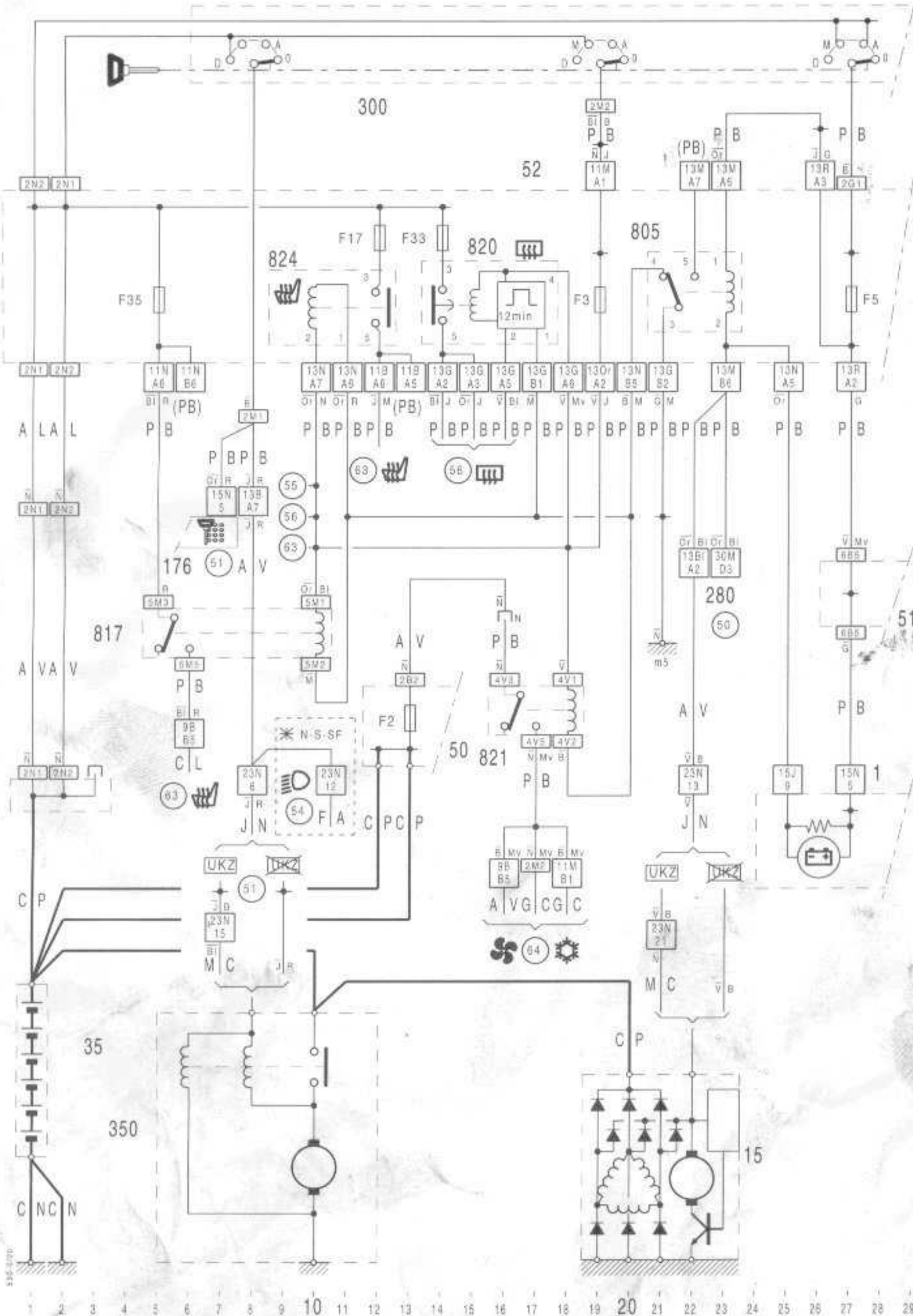

530-0/20

530-0/20



53

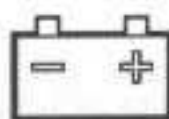

XM
530-0/20b

3

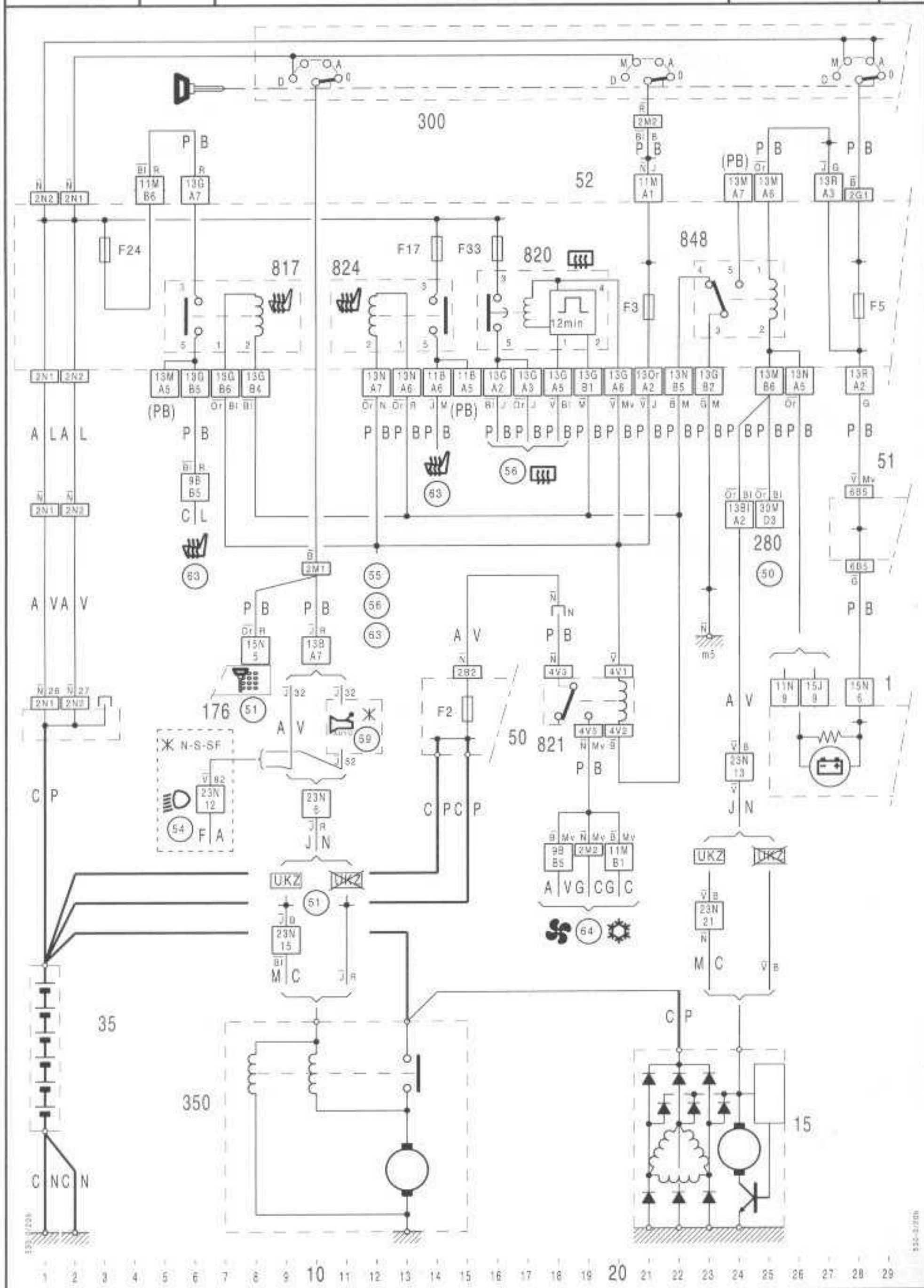

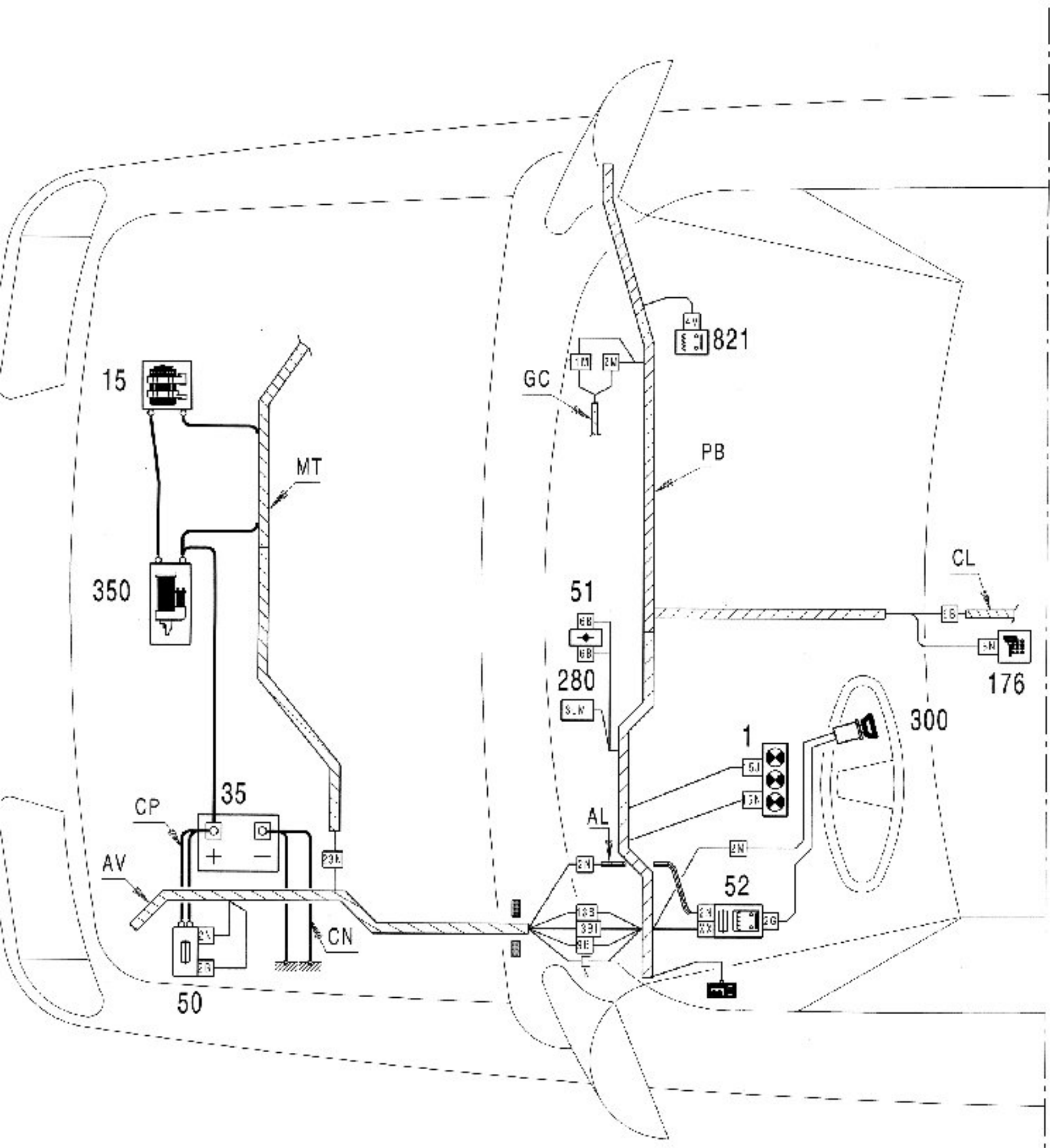
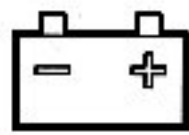

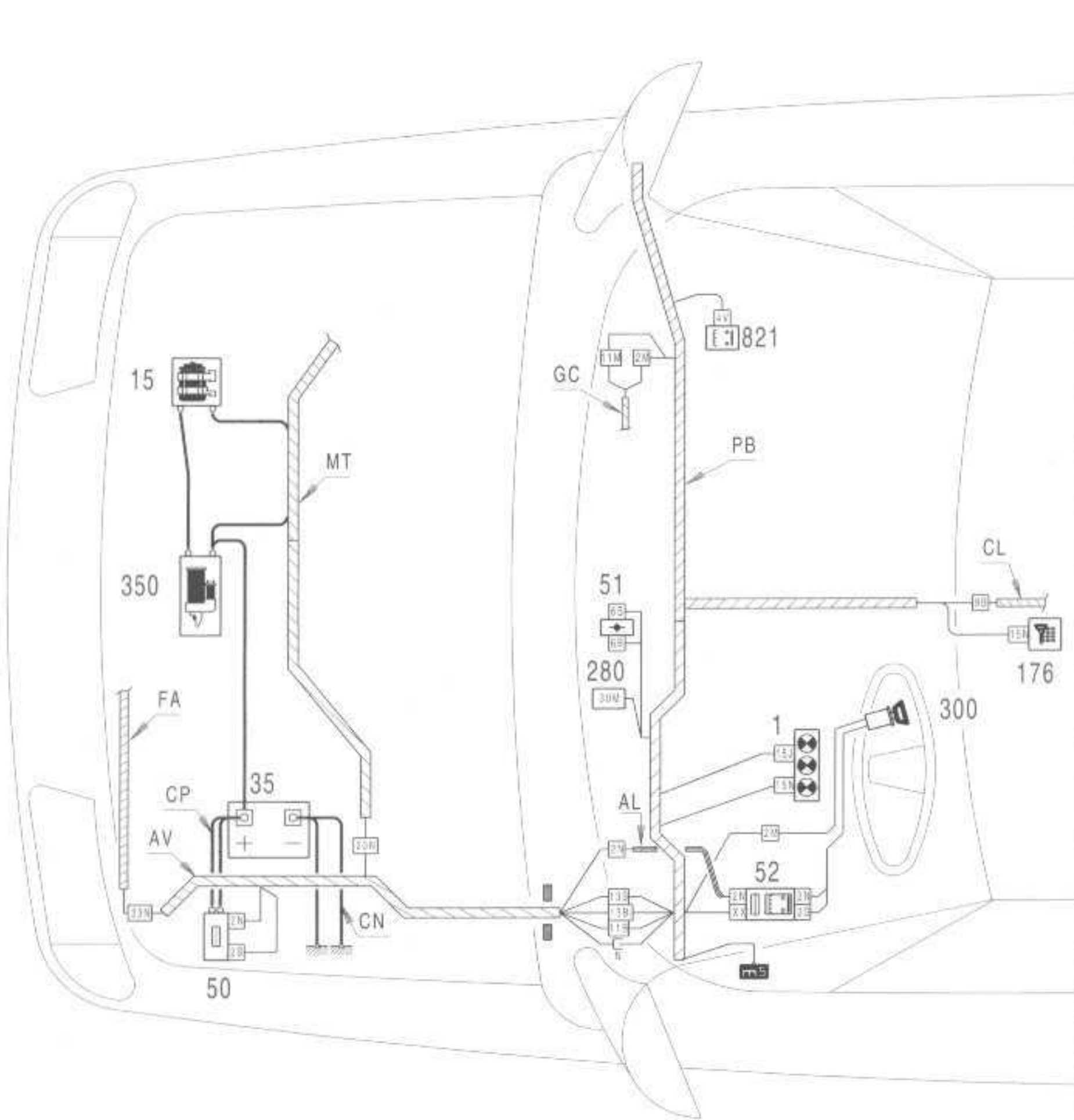
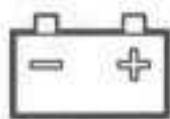



53

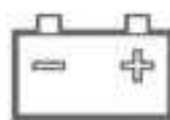

XM
530-0/20e

3

